

Varenummer: 20967425
Beskrivelse: E+G Justerfod
GN 343.7-25-M6 -A

Mål

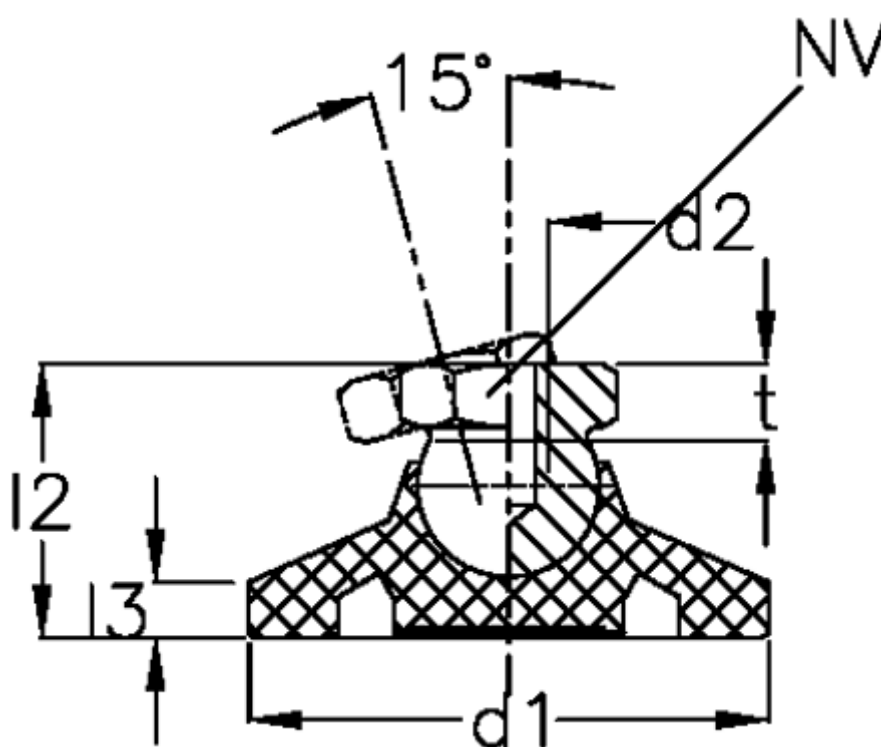

d1	= 25
d2	= M 6
l2	= 18.5
l3	= 4.0
NV	= 12
Statisk belastning (N)	= 5000
t min	= 9.0